

# Steel Pipe Fittings

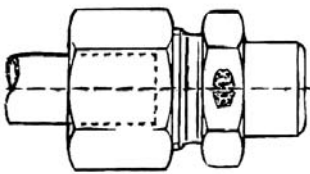

# Steel Pipe Fittings DIN2353

## Welding Straight Fittings



Part No.	Description	Price (ZAR)
311-06L	AS 06L	
311-08L	AS 08L	
311-10L	AS 10L	
311-12L	AS 12L	
311-15L	AS 15L	
311-18L	AS 18L	
131-22L	AS 22L	
131-28L	AS 28L	
311-35L	AS 35L	
311-42L	AS 42L	
311-06S	AS 06S	
311-08S	AS 08S	
311-10S	AS 10S	
311-12S	AS 12S	
311-14S	AS 14S	
311-16S	AS 16S	
311-20S	AS 20S	
311-25S	AS 25S	
311-30S	AS 30S	
311-38S	AS 38S	

## Blanking Plug

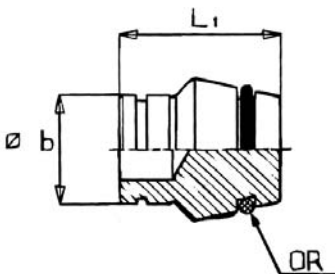

744-06L/S	BUZ 06L/S	
744-08L/S	BUZ 08L/S	
744-10L/S	BUZ 10L/S	
744-12L/S	BUZ 12L/S	
744-14S	BUZ 14S	
744-15L	BUZ 15L	
744-16S	BUZ 16S	
744-18L	BUZ 18L	
744-20S	BUZ 20S	
744-22L	BUZ 22L	
744-25S	BUZ 25S	
744-28L	BUZ 28L	
744-30S	BUZ 30S	
744-35L	BUZ 35L	
744-38S	BUZ 38S	
744-42L	BUZ 42L	

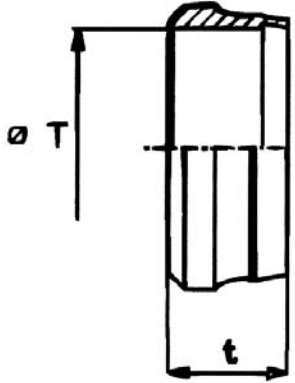
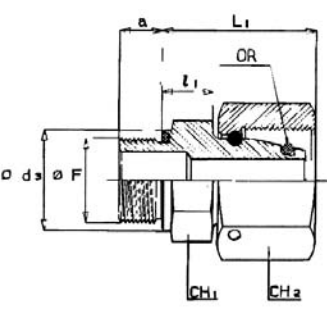
	Part No.	Description	Price (ZAR)
<p><b>Cutting Rings</b></p> 	342-04LL	D 04LL	
	342-06LL	D 06LL	
	342-08LL	D 08LL	
	342-06L/S	D 06L/S	
	342-08L/S	D 08L/S	
	342-10L/S	D 10L/S	
	324-12L/S	D 15L/S	
	342-15L	D 15L	
	342-18L	D 18L	
	322-22L	D 22L	
	342-28L	D 28L	
	342-35L	D 35L	
	342-42L	D 42L	
	342-14S	D 14S	
	342-16S	D 16S	
	342-20S	D 20S	
	342-25S	D 25S	
	342-30S	D 30S	
	342-38S	D 38S	
	<p><b>Preassembled Stud standpipe couplings with taper and OR, soft seal</b></p> 	717-106L	EGE 06 LRED
717-108L		EGE 08 LRED	
717-110L		EGE 10 LRED	
717-112L		EGE 12 LRED	
717-115L		EGE 15 LRED	
717-118L		EGE 18 LRED	
717-122L		EGE 22 LRED	
717-128L		EGE 28 LRED	
717-135L		EGE 35 LRED	
717-142L		EGE 42 LRED	
717-106S		EGE 06 SRED	
717-108S		EGE 08 SRED	
717-110S		EGE 10 SRED	
717-112S		EGE 12 SRED	
717-114S		EGE 14 SRED	
717-116S		EGE 16 SRED	
717-120S		EGE 20 SRED	
717-125S		EGE 25 SRED	
717-130S		EGE 30 SRED	
717-138S		EGE 38 SRED	

# Steel Pipe Fittings DIN2353

**Stud Standpipe couplings - soft seal**

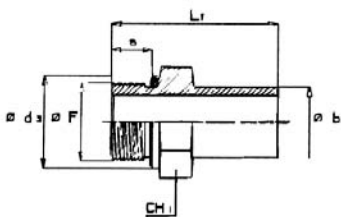

Part No.	Description	Price (ZAR)
412 - 106L	EVGE 06 LRED	
412 - 108L	EVGE 08 LRED	
412 - 110L	EVGE 10 LRED	
412 - 112L	EVGE 12 LRED	
412 - 115L	EVGE 15 LRED	
412 - 118L	EVGE 18 LRED	
412 - 122L	EVGE 22 LRED	
412 - 128L	EVGE 28 LRED	
412 - 135L	EVGE 35 LRED	
412 - 142L	EVGE 42 LRED	
412 - 106S	EVGE 06 SRED	
412 - 108S	EVGE 08 SRED	
412 - 110S	EVGE 10 SRED	
412 - 112S	EVGE 12 SRED	
412 - 114S	EVGE 14 SRED	
412 - 116S	EVGE 16 SRED	
412 - 120S	EVGE 20 SRED	
412 - 125S	EVGE 25 SRED	
412 - 130S	EVGE 30 SRED	
412 - 138S	EVGE 38 SRED	

**Adjustable male stud T with taper and O-Ring**

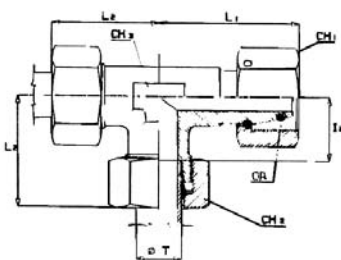

787 - 06L	EL 06L	
787 - 08L	EL 08L	
787 - 10L	EL 10L	
787 - 12L	EL 12L	
787 - 15L	EL 15L	
787 - 18L	EL 18L	
787 - 22L	EL 22L	
787 - 28L	EL 28L	
787 - 35L	EL 35L	
787 - 42L	EL 42L	
787 - 06S	EL 06S	
787 - 08S	EL 08S	
787 - 10S	EL 10S	
787 - 12S	EL 12S	
787 - 14S	EL 14S	
787 - 16S	EL 16S	
787 - 20S	EL 20S	
787 - 25S	EL 25S	
787 - 30S	EL 30S	
787 - 38S	EL 38S	

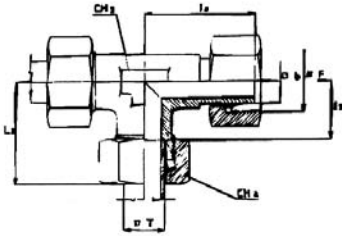
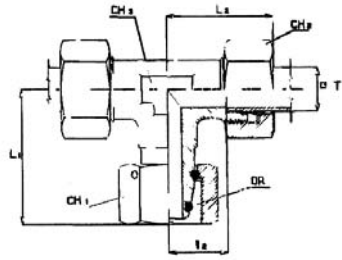
	Part No.	Description	Price (ZAR)	
<p style="text-align: center;"><b>Swivel T male stud type preassembled</b></p> 	287 - 06L	EVL 06L		
	287 - 08L	EVL 08L		
	287 - 10L	EVL 10L		
	287 - 12L	EVL 12L		
	287 - 15L	EVL 15L		
	287 - 18L	EVL 18L		
	287 - 22L	EVL 22L		
	287 - 28L	EVL 28L		
	287 - 35L	EVL 35L		
	287 - 42L	EVL 42L		
	287 - 06S	EVL 06S		
	287 - 08S	EVL 08S		
	287 - 10S	EVL 10S		
	287 - 12S	EVL 12S		
	287 - 14S	EVL 14S		
	287 - 16S	EVL 16S		
	287 - 20S	EVL 20S		
	287 - 25S	EVL 25S		
	287 - 30S	EVL 30S		
	287 - 38S	EVL 38S		
	<p style="text-align: center;"><b>Adjustable T with taper and O-Ring</b></p> 	757 - 06L	ET 06L	
		757 - 08L	ET 08L	
		757 - 10L	ET 10L	
		757 - 12L	ET 12L	
757 - 15L		ET 15L		
757 - 18L		ET 18L		
757 - 22L		ET 22L		
757 - 28L		ET 28L		
757 - 35L		ET 35L		
757 - 42L		ET 42L		
757 - 06S		ET 06S		
757 - 08S		ET 08S		
757 - 10S		ET 10S		
757 - 12S		ET 12S		
757 - 14S		ET 14S		
757 - 16S		ET 16S		
757 - 20S		ET 20S		
757 - 25S		ET 25S		
757 - 30S		ET 30S		
757 - 38S		ET 38S		

# Steel Pipe Fittings DIN2353

**Swivel T  
male stud type  
preassembled**

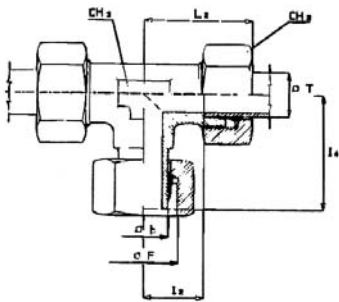

Part No.	Description	Price (ZAR)
257 - 06L	EVT 06L	
257 - 08L	EVT 08L	
257 - 10L	EVT 10L	
257 - 12L	EVT 12L	
257 - 15L	EVT 15L	
257 - 18L	EVT 18L	
257 - 22L	EVT 22L	
257 - 23L	EVT 23L	
257 - 35L	EVT 35L	
257 - 42L	EVT 42L	
257 - 06S	EVT 06S	
257 - 08S	EVT 08S	
257 - 10S	EVT 10S	
257 - 12S	EVT 12S	
257 - 14S	EVT 14S	
257 - 16S	EVT 16S	
257 - 20S	EVT 20S	
257 - 25S	EVT 25S	
257 - 30S	EVT 30S	
257 - 38S	EVT 38S	

**Adjustable male  
stud elbow with  
taper O-ring**

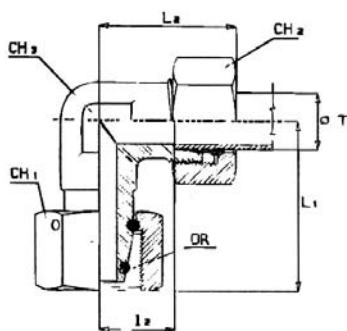

737 - 06L	EW 06L	
737 - 08L	EW 08L	
737 - 10L	EW 10L	
737 - 12L	EW 12L	
737 - 15L	EW 15L	
737 - 18L	EW 18L	
737 - 22L	EW 22L	
737 - 28L	EW 28L	
737 - 35L	EW 35L	
737 - 42L	EW 42L	
737 - 06S	EW 06S	
737 - 08S	EW 08S	
737 - 10S	EW 10S	
737 - 12S	EW 12S	
737 - 14S	EW 14S	
737 - 16S	EW 16S	
737 - 20S	EW 20S	
737 - 25S	EW 25S	
737 - 30S	EW 30S	
737 - 38S	EW 38S	

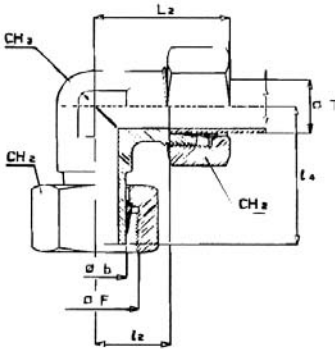
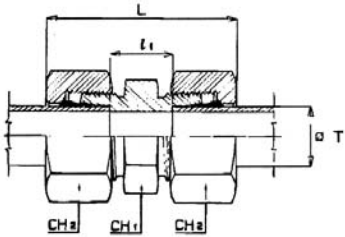
	Part No.	Description	Price (ZAR)
<p><b>Swivel elbow male stud type preassembled</b></p> 	237 - 06L	EVW 06L	
	237 - 08L	EVW 08L	
	237 - 10L	EVW 10L	
	237 - 12L	EVW 12L	
	237 - 15L	EVW 15L	
	237 - 18L	EVW 18L	
	237 - 22L	EVW 22L	
	237 - 28L	EVW 28L	
	237 - 35L	EVW 35L	
	237 - 42L	EVW 42L	
	237 - 06S	EVW 06S	
	237 - 08S	EVW 08S	
	237 - 10S	EVW 10S	
	237 - 12S	EVW 12S	
	237 - 14S	EVW 14S	
	237 - 16S	EVW 16S	
	237 - 20S	EVW 20S	
	237 - 25S	EVW 25S	
	237 - 30S	EVW 30S	
	237 - 38S	EVW 38S	
<p><b>Straight union fittings</b></p> 	221 - 04LL	G 04LL	
	221 - 06LL	G 06LL	
	221 - 08LL	G 08LL	
	221 - 06L	G 06L	
	221 - 08L	G 08L	
	221 - 10L	G 10L	
	221 - 12L	G 12L	
	221 - 15L	G 15L	
	221 - 18L	G 18L	
	221 - 22L	G 22L	
	221 - 28L	G 28L	
	221 - 35L	G 35L	
	221 - 42L	G 42L	
	221 - 06S	G 06S	
	221 - 08S	G 08S	
	221 - 10S	G 10S	
	221 - 12S	G 12S	
	221 - 14S	G 14S	
	221 - 16S	G 16S	
	221 - 20S	G 20S	
221 - 25S	G 25S		
221 - 30S	G 30S		
221 - 38S	G 38S		

# Steel Pipe Fittings DIN2353

## Female stud couplings

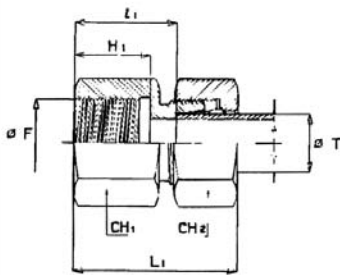

Part No.	Description	Price (ZAR)
431 - 106L	GAI 06LR	
431 - 108L	GAI 08LR	
431 - 110L	GAI 10LR	
431 - 112L	GAI 12LR	
431 - 115L	GAI 15LR	
431 - 118L	GAI 18LR	
431 - 122L	GAI 22LR	
431 - 128L	GAI 28LR	
431 - 135L	GAI 35LR	
431 - 142L	GAI 42LR	
431 - 106S	GAI 06SR	
431 - 108S	GAI 08SR	
431 - 110S	GAI 10SR	
431 - 112S	GAI 12SR	
431 - 114S	GAI 14SR	
431 - 116S	GAI 16SR	
431 - 120S	GAI 20SR	
431 - 125S	GAI 25SR	
431 - 130S	GAI 30SR	
431 - 138S	GAI 38SR	

## Straight end fittings

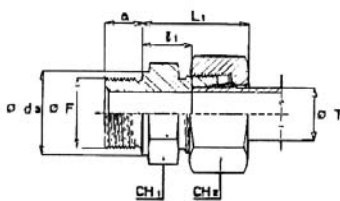

211 - 04LL	GE 04LLR	
211 - 06LL	GE 06LLR	
211 - 08LL	GE 08LLR	
211 - 106L	GE 06LR	
211 - 106L	GE 06LR 1/4"	
211 - 108L	GE 08LR	
211 - 108L	GE 08LR 3/8"	
211 - 110L	GE 10LR	
211 - 110L	GE 10LR 3/8"	
211 - 110L	GE 10LR 1/2"	
211 - 112L	GE 12LR	
211 - 112L	GE 12LR 1/4"	
211 - 112L	GE 12LR 1/2"	
211 - 115L	GE 15LR	
211 - 115L	GE 15LR 3/8"	
211 - 118L	GE 18LR	
211 - 122L	GE 22LR	
211 - 122L	GE 22LR 1/2"	
211 - 128L	GE 28LR	
211 - 135L	GE 35LR	
211 - 142L	GE 42LR	

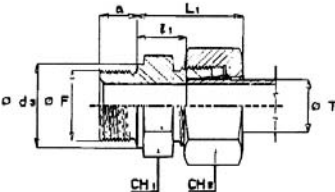
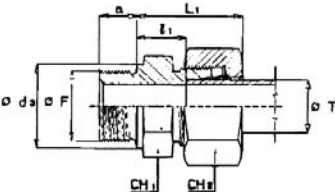

	Part No.	Description	Price (ZAR)	
<p style="text-align: center;"><b>Straight end fittings</b></p> 	211 - 106S	GE 06SR		
	211 - 106S	GE 06SR 3/8"		
	211 - 108S	GE 08SR		
	211 - 108S	GE 08SR 3/8"		
	211 - 110S	GE 10SR		
	211 - 110S	GE 10SR 1/4"		
	211 - 110S	GE 10SR 1/2"		
	211 - 112S	GE 12SR		
	211 - 112S	GE 12SR 1/4"		
	211 - 112S	GE 12SR 1/2"		
	211 - 114S	GE 14SR		
	211 - 114S	GE 14SR 3/8"		
	211 - 116S	GE 16SR		
	211 - 116S	GE 16SR 3/8"		
	211 - 116S	GE 16SR 3/4"		
	211 - 120S	GE 20SR		
	211 - 120S	GE 20SR 1/2"		
	211 - 120S	GE 20SR 1"		
	211 - 125S	GE 25SR		
	211 - 125S	GE 25SR 3/4"		
	211 - 130S	GE 30SR		
	211 - 130S	GE 30SR 1"		
	211 - 138S	GE 38SR		
	211 - 138S	GE 38SR 1 1/4"		
	211 - 138S	GE 38SR 1"		
	<p style="text-align: center;"><b>Straight end fittings</b></p> 	211 - 306L	GE 06LM	
		211 - 308L	GE 08LM	
		211 - 310L	GE 10LM	
211 - 312L		GE 12LM		
211 - 315L		GE 15LM		
211 - 318L		GE 18LM		
211 - 322L		GE 22LM		
211 - 328L		GE 28LM		
211 - 335L		GE 35LM		
211 - 342L		GE 42LM		
211 - 306S		GE 06SM		
211 - 308S		GE 08SM		
211 - 310S		GE 10SM		
211 - 312S		GE 12SM		
211 - 314S		GE 14SM		
211 - 316S		GE 16SM		
211 - 320S		GE 20SM		
211 - 325S		GE 25SM		
211 - 330S		GE 30SM		
211 - 380S		GE 38SM		

# Steel Pipe Fittings DIN2353

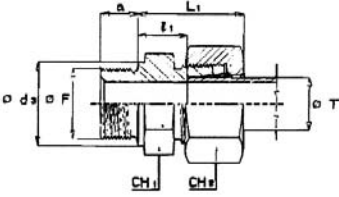
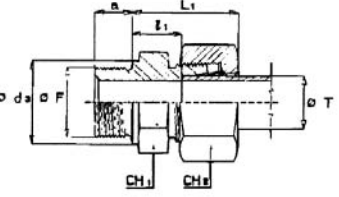
	Part No.	Description	Price (ZAR)
<p><b>Straight end fittings</b></p> 	211 - 506L	GE 06L/NPT	
	211 - 506L	GE 06L/NPT 1/4" NPT	
	211 - 508L	GE 08L/NPT	
	211 - 510L	GE 10L/NPT	
	211 - 510L	GE 10L/ 3/8" NPT	
	211 - 512L	GE 12L/NPT	
	211 - 512L	GE 12L/ 1 1/4" NPT	
	211 - 512L	GE 12L/ 1/2"NPT	
	211 - 515L	GE 15L/NPT	
	211 - 515L	GE 15L/ 1 3/8" NPT	
	211 - 518L	GE 18L/NPT	
	211 - 522L	GE 22L/NPT	
	211 - 528L	GE 28L/NPT	
	211 - 535L	GE 35L/NPT	
	211 - 542L	GE 42L/NPT	
	211 - 506S	GE 06S/NPT	
	211 - 508S	GE 08S/NPT	
	211 - 510S	GE 10S/NPT	
	211 - 510S	GE 10S/ 1/4" NPT	
	211 - 512S	GE 12S/NPT	
	211 - 512S	GE 12S/ 1/2"NPT	
	211 - 514S	GE 14S/NPT	
	211 - 516S	GE 16S/NPT	
	211 - 520S	GE 20S/NPT	
	211 - 525S	GE 25S/NPT	
	211 - 530S	GE 30S/NPT	
211 - 538S	GE 38S/NPT		
<p><b>Straight end fittings</b></p> 	212 - 106L	GE 06 LRED	
	212 - 108L	GE 08 LRED	
	212 - 110L	GE 10 LRED	
	212 - 112L	GE 12 LRED	
	212 - 115L	GE 15 LRED	
	212 - 118L	GE 18 LRED	
	212 - 122L	GE 22 LRED	
	212 - 128L	GE 28 LRED	
	212 - 135L	GE 35 LRED	
	212 - 142L	GE 42 LRED	
	212 - 106S	GE 06 SRED	
	212 - 108S	GE 08 SRED	
	212 - 110S	GE 10 SRED	
	212 - 112S	GE 12 SRED	
	212 - 114S	GE 14 SRED	
	212 - 116S	GE 16 SRED	
	212 - 120S	GE 20 SRED	

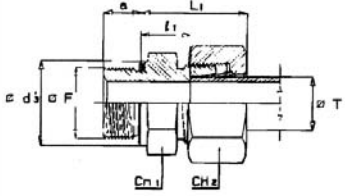
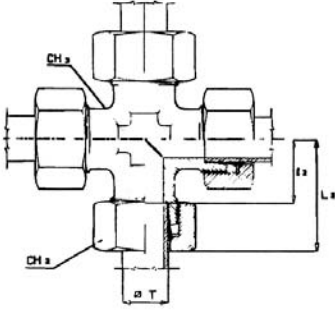
	Part No.	Description	Price (ZAR)	
<p><b>Straight end fittings with gasket metric</b></p> 	212 - 1255	GE 25 SRED		
	212 - 1308	GE 30 SRED		
	212 - 1388	GE 38 SRED		
	212 - 306L	GE 06 LMED		
	212 - 308L	GE 08 LMED		
	212 - 310L	GE 10 LMED		
	212 - 312L	GE 12 LMED		
	212 - 315L	GE 15 LMED		
	212 - 318L	GE 18 LMED		
	212 - 322L	GE 22 LMED		
	212 - 328L	GE 28 LMED		
	212 - 335L	GE 35 LMED		
	212 - 342L	GE 42 LMED		
	212 - 306S	GE 06 SMED		
	212 - 308S	GE 08 SMED		
	212 - 310S	GE 10 SMED		
	212 - 312S	GE 12 SMED		
	212 - 314S	GE 14 SMED		
	212 - 316S	GE 16 SMED		
	212 - 320S	GE 20 SMED		
	212 - 325S	GE 25 SMED		
	212 - 330S	GE 30 SMED		
	212 - 338S	GE 38 SMED		
	<p><b>Cross union fittings</b></p> 	301 - 06L	K 06L	
		301 - 08L	K 08L	
		301 - 10L	K 10L	
		301 - 12L	K 12L	
		301 - 15L	K 15L	
		301 - 18L	K 18L	
		301 - 22L	K 22L	
		301 - 28L	K 28L	
		301 - 35L	K 35L	
		301 - 42L	K 42L	
301 - 06S		K 06S		
301 - 08S		K 08S		
301 - 10S		K 10S		
301 - 12S		K 12S		
301 - 14S		K 14S		
301 - 16S		K 16S		
301 - 20S		K 20S		
301 - 25S		K 25S		
301 - 30S		K 30S		
301 - 38S		K 38S		

# Steel Pipe Fittings DIN2353

	Part No.	Description	Price (ZAR)
	502 - 08/06L	KOR 08/06L	
	502 - 10/06L	KOR 10/06L	
	502 - 10/08L	KOR 10/08L	
	502 - 12/06L	KOR 12/06L	
	502 - 12/08L	KOR 12/08L	
	502 - 12/10L	KOR 12/10L	
	502 - 15/06L	KOR 15/06L	
	502 - 15/08L	KOR 15/08L	
	502 - 15/10L	KOR 15/10L	
	502 - 15/12L	KOR 15/12L	
	502 - 18/06L	KOR 18/06L	
	502 - 18/08L	KOR 18/08L	
	502 - 18/10L	KOR 18/10L	
	502 - 18/12L	KOR 18/12L	
	502 - 18/15L	KOR 18/15L	
	502 - 22/06L	KOR 22/06L	
	502 - 22/08L	KOR 22/08L	
	502 - 22/10L	KOR 22/10L	
	502 - 22/12L	KOR 22/12L	
	502 - 22/15L	KOR 22/15L	
	502 - 22/18L	KOR 22/18L	
	502 - 28/06L	KOR 28/06L	
	502 - 28/08L	KOR 28/08L	
	502 - 28/10L	KOR 28/10L	
	502 - 28/12L	KOR 28/12L	
	502 - 28/15L	KOR 28/15L	
	502 - 28/18L	KOR 28/18L	
	502 - 28/22L	KOR 28/22L	
	502 - 35/06L	KOR 35/06L	
	502 - 35/08L	KOR 35/08L	
	502 - 35/10L	KOR 35/10L	
	502 - 35/12L	KOR 35/12L	
	502 - 35/15L	KOR 35/15L	
	502 - 35/18L	KOR 35/18L	
	502 - 35/22L	KOR 35/22L	
	502 - 35/28L	KOR 35/28L	
	502 - 42/06L	KOR 42/06L	
	502 - 42/08L	KOR 42/08L	
	502 - 42/10L	KOR 42/10L	
	502 - 42/12L	KOR 42/12L	
	502 - 42/15L	KOR 42/15L	
	502 - 42/18L	KOR 42/18L	
	502 - 42/22L	KOR 42/22L	
	502 - 42/28L	KOR 42/28L	
	502 - 42/35L	KOR 42/35L	

**Standpipe reducing fittings, preassembled**

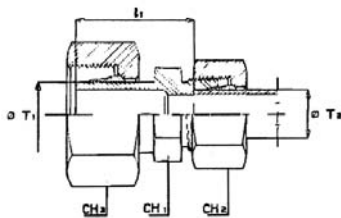

# Steel Pipe Fittings DIN2353

	Part No.	Description	Price (ZAR)
	502 - 08/06S	KOR 08/06S	
	502 - 10/06S	KOR 10/06S	
	502 - 10/08S	KOR 10/08S	
	502 - 12/06S	KOR 12/06S	
	502 - 12/08S	KOR 12/08S	
	502 - 12/10S	KOR 12/10S	
	502 - 14/06S	KOR 14/06S	
	502 - 14/08S	KOR 14/08S	
	502 - 14/10S	KOR 14/10S	
	502 - 14/12S	KOR 14/12S	
	502 - 16/06S	KOR 16/06S	
	502 - 16/08S	KOR 18/08S	
	502 - 16/10S	KOR 16/10S	
	502 - 16/12S	KOR 16/12S	
	502 - 16/14S	KOR 16/14S	
	502 - 20/06S	KOR 20/06S	
	502 - 20/08S	KOR 20/08S	
	502 - 20/10S	KOR 20/10S	
	502 - 20/12S	KOR 20/12S	
	502 - 20/14S	KOR 20/14S	
	502 - 20/16S	KOR 20/16S	
	502 - 25/06S	KOR 25/06S	
	502 - 25/08S	KOR 25/08S	
	502 - 25/10S	KOR 25/10S	
	502 - 25/12S	KOR 25/12S	
	502 - 25/14S	KOR 25/14S	
	502 - 25/16S	KOR 25/16S	
	502 - 25/20S	KOR 25/20S	
	502 - 30/06S	KOR 30/06S	
	502 - 30/08S	KOR 30/08S	
	502 - 30/10S	KOR 30/10S	
	502 - 30/12S	KOR 30/12S	
	502 - 30/14S	KOR 30/14S	
	502 - 30/16S	KOR 30/16S	
	502 - 30/20S	KOR 30/20S	
	502 - 30/25S	KOR 30/25S	
	502 - 38/06S	KOR 38/06S	
	502 - 38/08S	KOR 38/08S	
	502 - 38/10S	KOR 38/10S	
	502 - 38/12S	KOR 38/12S	
	502 - 38/14S	KOR 38/14S	
	502 - 38/16S	KOR 38/16S	
	502 - 38/20S	KOR 38/20S	
	502 - 38/25S	KOR 38/25S	
	502 - 38/30S	KOR 38/30S	

**Standpipe reducing fittings, preassembled**

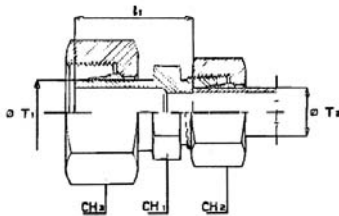

# Steel Pipe Fittings DIN2353

## L end fittings

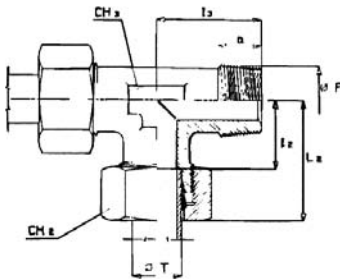

Part No.	Description	Price (ZAR)
281 - 506L	LE 06L / NPT	
281 - 508L	LE 08L / NPT	
281 - 510L	LE 10L / NPT	
281 - 512L	LE 12L / NPT	
281 - 515L	LE 15L / NPT	
281 - 518L	LE 18L / NPT	
281 - 522L	LE 22L / NPT	
281 - 528L	LE 28L / NPT	
281 - 535L	LE 35L / NPT	
281 - 542L	LE 42L / NPT	
281 - 506S	LE 06S / NPT	
281 - 508S	LE 08S / NPT	
281 - 510S	LE 10S / NPT	
281 - 512S	LE 12S / NPT	
281 - 514S	LE 14S / NPT	
281 - 516S	LE 16S / NPT	
281 - 520S	LE 20S / NPT	
281 - 525S	LE 25S / NPT	
281 - 530S	LE 30S / NPT	
281 - 538S	LE 38S / NPT	

## Straight end fittings with gasket

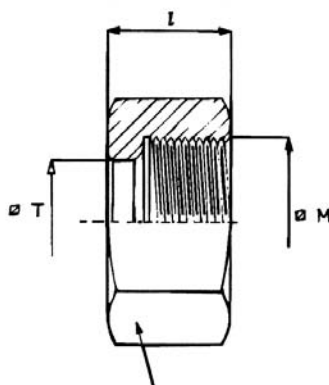

341 - 04LL	M 04LL	
341 - 06LL	M 06LL	
341 - 08LL	M 08LL	
341 - 06L	M 06L	
341 - 08L	M 08L	
341 - 10L	M 10L	
341 - 12L	M 12L	
341 - 15L	M 15L	
341 - 18L	M 18L	
341 - 22L	M 22L	
341 - 28L	M 28L	
341 - 35L	M 35L	
341 - 42L	M 42L	
341 - 06S	M 06S	
341 - 08S	M 08L	
341 - 10S	M 10S	
341 - 12S	M 12S	
341 - 14S	M 14S	
341 - 16S	M 16S	
341 - 20S	M 20S	
341 - 25S	M 25S	
341 - 30S	M 30S	
341 - 38S	M 38S	

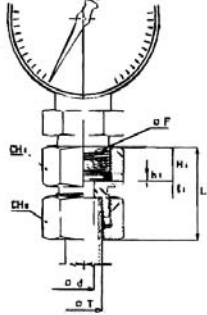
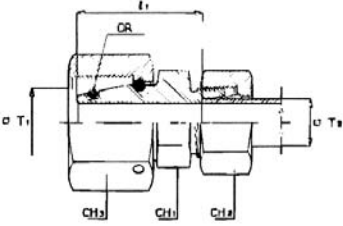
	Part No.	Description	Price (ZAR)	
<p><b>Guage fittings</b></p> 	401 - 106L	MAV 06LR		
	401 - 108L	MAV 08LR		
	401 - 110L	MAV 10LR		
	401 - 112L	MAV 12LR		
	401 - 106S	MAV 06SR		
	401 - 108S	MAV 08SR		
	401 - 110S	MAV 10SR		
	401 - 112S	MAV 12SR		
	402 - 106L	MAVEV 06LR		
	402 - 108L	MAVEV 08LR		
	402 - 110L	MAVEV 10LR		
	402 - 112L	MAVEV 12LR		
	402 - 106S	MAVEV 06SR		
	402 - 108S	MAVEV 08SR		
	402 - 110S	MAVEV 10SR		
	402 - 112S	MAVEV 12SR		
	<p><b>Reducing fittings with taper and O-Ring "S"</b></p> 	707 - 08/06L	RED 08/06L	
707 - 10/06L		RED 10/06L		
707 - 10/08L		RED 10/08L		
707 - 12/06L		RED 12/06L		
707 - 12/08L		RED 12/08L		
707 - 12/10L		RED 12/10L		
707 - 15/06L		RED 15/06L		
707 - 15/08L		RED 15/08L		
707 - 15/10L		RED 15/10L		
707 - 15/12L		RED 15/12L		
707 - 18/06L		RED 18/06L		
707 - 18/08L		RED 18/08L		
707 - 18/10L		RED 18/10L		
707 - 18/12L		RED 18/12L		
707 - 18/15L		RED 18/15L		
707 - 22/06L		RED 22/06L		
707 - 22/08L		RED 22/08L		
707 - 22/10L		RED 22/10L		
707 - 22/12L		RED 22/12L		
707 - 22/15L		RED 22/15L		
707 - 22/18L		RED 22/18L		

# Steel Pipe Fittings DIN2353

## Reducing fittings with taper and O-Ring "S"

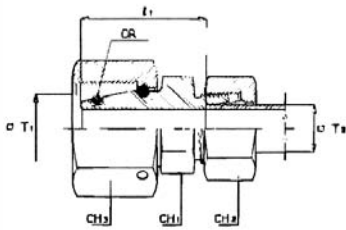

Part No.	Description	Price (ZAR)
707 - 28/06L	RED 22/06L	
707 - 28/08L	RED 22/08L	
707 - 28/10L	RED 22/10L	
707 - 28/12L	RED 22/12L	
707 - 28/15L	RED 22/15L	
707 - 28/18L	RED 22/18L	
707 - 28/22L	RED 22/22L	
707 - 35/15L	RED 35/15L	
707 - 35/18L	RED 35/18L	
707 - 35/22L	RED 35/22L	
707 - 35/28L	RED 35/28L	
707 - 42/18L	RED 42/18L	
707 - 42/22L	RED 42/22L	
707 - 42/28L	RED 42/28L	
707 - 42/35L	RED 42/35L	

## Standpipe reducing fittings, preassembled

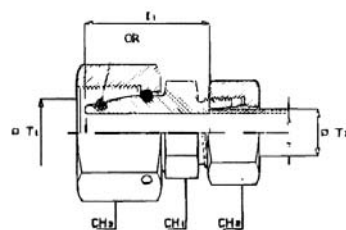

707 - 28/06S	RED 08/06S	
707 - 10/06S	RED 10/06S	
707 - 10/08S	RED 10/08S	
707 - 12/06S	RED 12/06S	
707 - 12/08S	RED 12/08S	
707 - 12/10S	RED 12/10S	
707 - 14/06S	RED 14/06S	
707 - 14/08S	RED 14/08S	
707 - 14/10S	RED 14/12S	
707 - 14/12S	RED 14/12S	
707 - 16/06S	RED 16/06S	
707 - 16/08S	RED 16/08S	
707 - 16/10S	RED 16/10S	
707 - 16/12S	RED 16/12S	
707 - 16/14S	RED 16/14S	
707 - 20/06S	RED 20/06S	
707 - 20/08S	RED 20/08S	
707 - 20/10S	RED 20/10S	
707 - 20/12S	RED 20/12S	
707 - 20/14S	RED 20/14S	
707 - 20/16S	RED 20/16S	

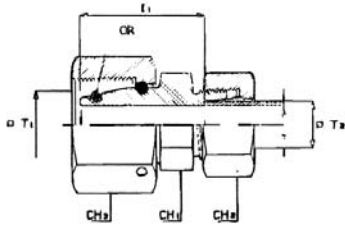
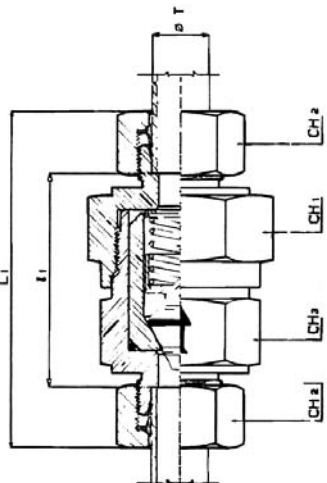

	Part No.	Description	Price (ZAR)
<p><b>Standpipe reducing fittings, preassembled</b></p> 	707 - 25/06S	RED 25/06S	
	707 - 25/08S	RED 25/08S	
	707 - 25/10S	RED 25/10S	
	707 - 25/12S	RED 25/12S	
	707 - 25/14S	RED 25/14S	
	707 - 25/16S	RED 25/16S	
	707 - 25/20S	RED 25/20S	
	707 - 30/08S	RED 30/08S	
	707 - 30/10S	RED 30/10S	
	707 - 30/12S	RED 30/12S	
	707 - 30/14S	RED 30/14S	
	707 - 30/16S	RED 30/16S	
	707 - 30/20S	RED 30/20S	
	707 - 30/25S	RED 30/25S	
	707 - 38/12S	RED 38/12S	
	707 - 38/14S	RED 38/14S	
	707 - 38/16S	RED 38/16S	
	707 - 38/20S	RED 38/20S	
	707 - 38/25S	RED 38/25S	
	707 - 38/30S	RED 38/30S	
	<p><b>Non-return valves Tube/Tube</b></p> 	821 - 06L	RHD 06L
821 - 08L		RHD 08L	
821 - 10L		RHD 10L	
821 - 12L		RHD 12L	
821 - 15L		RHD 15L	
821 - 18L		RHD 18L	
821 - 22L		RHD 22L	
821 - 28L		RHD 28L	
821 - 35L		RHD 35L	
821 - 42L		RHD 42L	
821 - 06S		RHD 06S	
821 - 08S		RHD 08S	
821 - 10S		RHD 10S	
821 - 12S		RHD 12S	
821 - 14S		RHD 14S	
821 - 16S		RHD 16S	
821 - 20S		RHD 20S	
821 - 25S		RHD 25S	
821 - 30S		RHD 30S	
821 - 38S		RHD 38S	

# Steel Pipe Fittings DIN2353

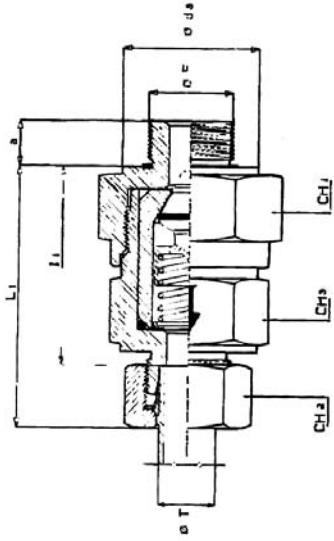
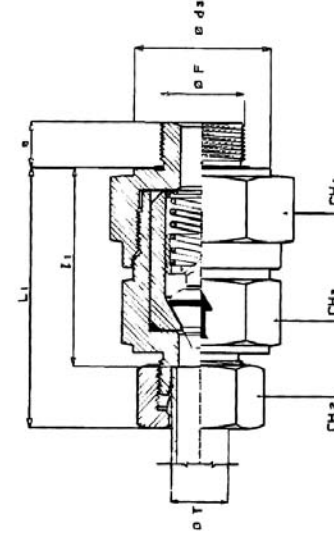
	Part No.	Description	Price (ZAR)
<p><b>Non-return valves Thread inlet</b></p> 	813-06L	RHV 06L	
	813-08L	RHV 08L	
	813-10L	RHV 10L	
	813-12L	RHV 12L	
	813-15L	RHV 15L	
	813-18L	RHV 18L	
	813-22L	RHV 22L	
	813-28L	RHV 28L	
	813-35L	RHV 35L	
	813-42L	RHV 42L	
	813-06S	RHV 06S	
	813-08S	RHV 08S	
	813-10S	RHV 10S	
	813-12S	RHV 12S	
	813-14S	RHV 14S	
	813-16S	RHV 16S	
	813-20S	RHV 20S	
	813-25S	RHV 25S	
	813-30S	RHV 30S	
	813-38S	RHV 38S	
<p><b>Non-return valves Thread outlet</b></p> 	812-06L	RHZ 06L	
	812-08L	RHZ 08L	
	812-10L	RHZ 10L	
	812-12L	RHZ 12L	
	812-15L	RHZ 15L	
	812-18L	RHZ 18L	
	812-22L	RHZ 22L	
	812-28L	RHZ 28L	
	812-35L	RHZ 35L	
	812-42L	RHZ 42L	
	812-06S	RHZ 06S	
	812-08S	RHZ 08S	
	812-10S	RHZ 10S	
	812-12S	RHZ 12S	
	812-14S	RHZ 14S	
	812-16S	RHZ 16S	
	812-20S	RHZ 20S	
	812-25S	RHZ 25S	
	812-30S	RHZ 30S	
	812-38S	RHZ 38S	

**Male - female  
reducing fittings**

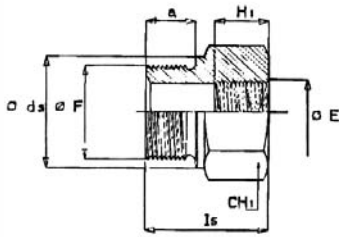

	Part No.	Description	Price (ZAR)
	421 - 1/8 x 1/4	RI 1/8 x 1/4	
	421 - 1/8 x 3/8	RI 1/8 x 3/8	
	421 - 1/4 x 1/8	RI 1/4 x 1/8	
	421 - 1/4 x 3/8	RI 1/4 x 3/8	
	421 - 1/4 x 1/2	RI 1/4 x 1/2	
	421 - 1/4 x 3/4	RI 1/4 x 3/4	
	421 - 3/8 x 1/8	RI 3/8 x 1/8	
	421 - 3/8 x 1/4	RI 3/8 x 1/4	
	421 - 3/8 x 1/2	RI 3/8 x 1/2	
	421 - 3/8 x 3/4	RI 3/8 x 3/4	
	421 - 1/2 x 1/8	RI 1/2 x 1/8	
	421 - 1/2 x 1/4	RI 1/2 x 1/4	
	421 - 1/2 x 3/8	RI 1/2 x 3/8	
	421 - 1/2 x 3/4	RI 1/2 x 3/4	
	421 - 1/2 x 1	RI 1/2 x 1	
	421 - 1/2 x 1 1/4	RI 1/2 x 1 1/4	
	421 - 3/4 x 1/4	RI 3/4 x 1/4	
	421 - 3/4 x 3/8	RI 3/4 x 3/8	
	421 - 3/4 x 1/2	RI 3/4 x 1/2	
	421 - 3/4 x 1	RI 3/4 x 1	
	421 - 3/4 x 1 1/4	RI 3/4 x 1 1/4	
	421 - 3/4 x 1 1/2	RI 3/4 x 1 1/2	
	421 - 1 x 1/4	RI 1 x 1/4	
	421 - 1 x 3/8	RI 1 x 3/8	
	421 - 1 x 1/2	RI 1 x 1/2	
	421 - 1 x 3/4	RI 1 x 3/4	
	421 - 1 x 1 1/4	RI 1 x 1 1/4	
	421 - 1 x 1 1/2	RI 1 x 1 1/2	
	421 - 1 1/4 x 1/2	RI 1 1/4 x 1/2	
	421 - 1 1/4 x 3/4	RI 1 1/4 x 3/4	
	421 - 1 1/4 x 1	RI 1 1/4 x 1	
	421 - 1 1/4 x 1 1/2	RI 1 1/4 x 1 1/2	
	421 - 1 1/2 x 1/2	RI 1 1/2 x 1/2	
	421 - 1 1/2 x 3/4	RI 1 1/2 x 3/4	
	421 - 1 1/2 x 1	RI 1 1/2 x 1	
	421 - 1 1/2 x 1 1/4	RI 1 1/2 x 1 1/4	

# Steel Pipe Fittings DIN2353

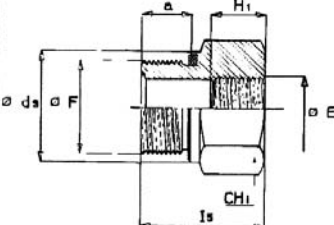
	Part No.	Description	Price (ZAR)
<p><b>Male - female reducing fittings with gasket</b></p> 	721 - 1/8 x 1/4	RI 1/8 x 1/4 ED	
	721 - 1/8 x 3/8	RI 1/8 x 3/8 ED	
	721 - 1/4 x 1/8	RI 1/4 x 1/8 ED	
	721 - 1/4 x 3/8	RI 1/4 x 3/8 ED	
	721 - 1/4 x 1/2	RI 1/4 x 1/2 ED	
	721 - 1/4 x 3/4	RI 1/4 x 3/4 ED	
	721 - 3/8 x 1/8	RI 3/8 x 1/8 ED	
	721 - 3/8 x 1/4	RI 3/8 x 1/4 ED	
	721 - 3/8 x 1/2	RI 3/8 x 1/2 ED	
	721 - 3/8 x 3/4	RI 3/8 x 3/4 ED	
	721 - 1/2 x 1/8	RI 1/2 x 1/8 ED	
	721 - 1/2 x 1/4	RI 1/2 x 1/4 ED	
	721 - 1/2 x 3/8	RI 1/2 x 3/8 ED	
	721 - 1/2 x 3/4	RI 1/2 x 3/4 ED	
	721 - 1/2 x 1	RI 1/2 x 1 ED	
	721 - 1/2 x 1 1/4	RI 1/2 x 1 1/4 ED	
	721 - 3/4 x 1/4	RI 3/4 x 1/4 ED	
	721 - 3/4 x 3/8	RI 3/4 x 3/8 ED	
	721 - 3/4 x 1/2	RI 3/4 x 1/2 ED	
	721 - 3/4 x 1	RI 3/4 x 1 ED	
	721 - 3/4 x 1 1/4	RI 3/4 x 1 1/4 ED	
	721 - 3/4 x 1 1/2	RI 3/4 x 1 1/2 ED	
	721 - 1 x 1/4	RI 1 x 1/4 ED	
	721 - 1 x 3/8	RI 1 x 3/8 ED	
	721 - 1 x 1/2	RI 1 x 1/2 ED	
	721 - 1 x 3/4	RI 1 x 3/4 ED	
	721 - 1 x 1 1/4	RI 1 x 1 1/4 ED	
	721 - 1 x 1 1/2	RI 1 x 1 1/2 ED	
	721 - 1 1/4 x 1/2	RI 1 1/4 x 1/2 ED	
	721 - 1 1/4 x 3/4	RI 1 1/4 x 3/4 ED	
	721 - 1 1/4 x 1	RI 1 1/4 x 1 ED	
	721 - 1 1/4 x 1 1/2	RI 1 1/4 x 1 1/2 ED	
	721 - 1 1/2 x 1/2	RI 1 1/2 x 1/2 ED	
	721 - 1 1/2 x 3/4	RI 1 1/2 x 3/4 ED	
	721 - 1 1/2 x 1	RI 1 1/2 x 1 ED	
	721 - 1 1/2 x 1 1/4	RI 1 1/2 x 1 1/4 ED	

# Steel Pipe Fittings DIN2353

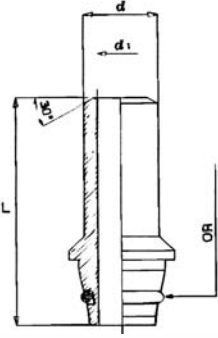
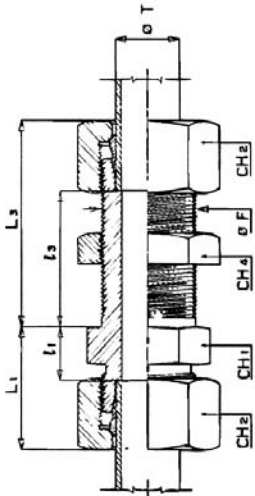
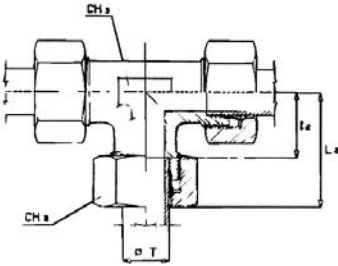
	Part No.	Description	Price (ZAR)	
<b>Straight end fittings</b> 	351 - 10S	SKA 10		
	351 - 12S	SKA 12		
	351 - 14S	SKA 14		
	351 - 16S	SKA 16		
	351 - 20S	SKA 20		
	351 - 25S	SKA 25		
	351 - 25 x 4	SKA 25 x 4		
	351 - 30 x 3	SKA 30 x 3		
	351 - 30 x 4	SKA 30 x 4		
	351 - 30 x 5	SKA 30 x 5		
	351 - 38 x 4	SKA 38 x 4		
	351 - 38 x 5	SKA 38 x 5		
	<b>Straight bulkhead fittings</b> 	312 - 06L	SV 06L	
		312 - 08L	SV 08L	
312 - 10L		SV 10L		
312 - 12L		SV 12L		
312 - 15L		SV 15L		
312 - 18L		SV 18L		
312 - 22L		SV 22L		
312 - 28L		SV 28L		
312 - 35L		SV 35L		
312 - 42L		SV 42L		
312 - 06S		SV 06S		
312 - 08S		SV 08S		
312 - 10S		SV 10S		
312 - 12S		SV 12S		
312 - 14S		SV 14S		
312 - 16S		SV 16S		
312 - 20S		SV 20S		
312 - 25S		SV 25S		
312 - 30S		SV 30S		
312 - 38S	SV 38S			
<b>T union fittings</b> 	261 - 04LL	T 04LL		
	261 - 06LL	T 06LL		
	261 - 08LL	T 08LL		
	261 - 06L	T 04L		
	261 - 08L	T 08L		
	261 - 10L	T 10L		
	261 - 12L	T 12L		
	261 - 15L	T 15L		
	261 - 18L	T 18L		
	261 - 22L	T 22L		
	261 - 28L	T 28L		
	261 - 35L	T 35L		
	261 - 42L	T 42L		

# Steel Pipe Fittings DIN2353

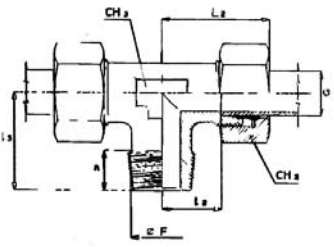
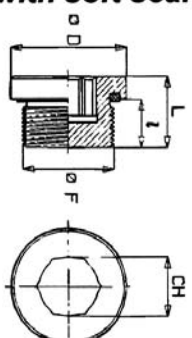
	Part No.	Description	Price (ZAR)
	261 - 06S	T 06S	
	261 - 08S	T 08S	
	261 - 10S	T 10S	
	261 - 12S	T 12S	
	261 - 14S	T 14S	
	261 - 16S	T 16S	
	261 - 20S	T 20S	
	261 - 25S	T 25S	
	261 - 30S	T 30S	
	261 - 38S	T 38S	
	<hr/>		
<p><b>T end fittings</b></p> 	251 - 06L	TE 06L / NPT	
	251 - 08L	TE 08L / NPT	
	251 - 10L	TE 10L / NPT	
	251 - 12L	TE 12L / NPT	
	251 - 15L	TE 15L / NPT	
	251 - 18L	TE 18L / NPT	
	251 - 22L	TE 22L / NPT	
	251 - 28L	TE 28L / NPT	
	251 - 35L	TE 35L / NPT	
	251 - 42L	TE 42L / NPT	
	251 - 06S	TE 06S / NPT	
	251 - 08S	TE 08S / NPT	
	251 - 10S	TE 10S / NPT	
	251 - 12S	TE 12S / NPT	
	251 - 14S	TE 14S / NPT	
	251 - 16S	TE 16S / NPT	
	251 - 20S	TE 20S / NPT	
	251 - 25S	TE 25S / NPT	
	251 - 30S	TE 30S / NPT	
	251 - 38S	TE 38S / NPT	
	<hr/>		
<p><b>Blanking plugs with soft seal</b></p> 	336 - 10 x 1	VISTI 10 x 1 ED	
	336 - 12 x 1.5	VISTI 12 x 1.5 ED	
	336 - 14 x 1.5	VISTI 14 x 1.5 ED	
	336 - 16 x 1.5	VISTI 16 x 1.5 ED	
	336 - 18 x 1.5	VISTI 18 x 1.5 ED	
	336 - 22 x 1.5	VISTI 22 x 1.5 ED	
	336 - 26 x 1.5	VISTI 26 x 1.5 ED	
	336 - 27 x 2	VISTI 27 x 2 ED	
	336 - 33 x 2	VISTI 33 x 2 ED	
	336 - 42 x 2	VISTI 42 x 2 ED	
	336 - 48 x 2	VISTI 48 x 2 ED	

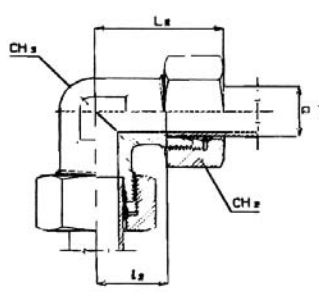
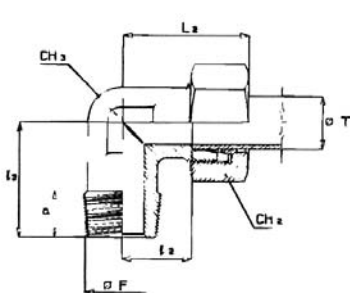
	Part No.	Description	Price (ZAR)
	336 - 1/8	VSTI 1/8" ED	
	336 - 1/4	VSTI 1/4" ED	
	336 - 3/8	VSTI 3/8" ED	
	336 - 1/2	VSTI 1/2" ED	
	336 - 3/4	VSTI 3/4" ED	
	336 - 1	VSTI 1" ED	
	336 - 1 1/4	VSTI 1 1/4" ED	
	336 - 1 1/2	VSTI 1 1/2" ED	
<p><b>Elbow union fittings</b></p> 	222 - 04LL	W 04LL	
	222 - 06LL	W 06LL	
	222 - 08LL	W 08LL	
	222 - 06L	W 06L	
	222 - 08L	W 08L	
	222 - 10L	W 10L	
	222 - 12L	W 12L	
	222 - 15L	W 15L	
	222 - 18L	W 18L	
	222 - 22L	W 22L	
	222 - 28L	W 28L	
	222 - 35L	W 35L	
	222 - 42L	W 42L	
	222 - 06S	W 06S	
	222 - 08S	W 08S	
	222 - 10S	W 10S	
	222 - 12S	W 12S	
	222 - 14S	W 14S	
	222 - 16S	W 16S	
	222 - 20S	W 20S	
	222 - 25S	W 25S	
222 - 30S	W 30S		
222 - 38S	W 38S		
<p><b>Elbow union fittings</b></p> 	231 - 504LL	WE 04LL / NPT	
	231 - 506LL	WE 06LL / NPT	
	231 - 508LL	WE 08LL / NPT	
	231 - 506L	WE 06L / NPT	
	231 - 506L	WE 06L / 1/4 NPT	
	231 - 508L	WE 08L / NPT	
	231 - 510L	WE 10L / NPT	
	231 - 512L	WE 12L / NPT	
	231 - 512L	WE 12L / 1/4 NPT	
	231 - 512L	WE 12L / 1/2 NPT	
	231 - 515L	WE 15L / NPT	
	231 - 518L	WE 18L / NPT	

# Steel Pipe Fittings DIN2353

## Elbow union fittings

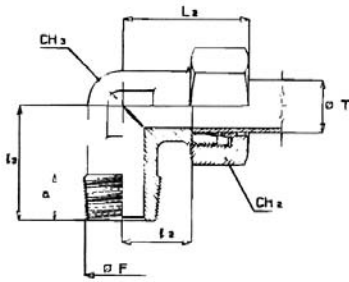

Part No.	Description	Price (ZAR)
231 - 522L	WE 22L / NPT	
231 - 528L	WE 28L / NPT	
231 - 535L	WE 35L / NPT	
231 - 542L	WE 42L / NPT	
231 - 506S	WE 06S / NPT	
231 - 508S	WE 08S / NPT	
231 - 510S	WE 10S / NPT	
231 - 510S	WE 10S / 1/4 NPT	
231 - 512S	WE 12S / NPT	
231 - 514S	WE 14S / NPT	
231 - 516S	WE 16S / NPT	
231 - 520S	WE 20S / NPT	
231 - 525S	WE 25S / NPT	
231 - 530S	WE 30S / NPT	
231 - 538S	WE 38S / NPT	

## Swivel fittings with O-Ring

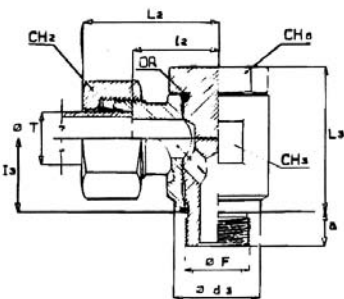

731 - 106L	WHO 06LR	
731 - 108L	WHO 08LR	
731 - 110L	WHO 10LR	
731 - 112L	WHO 12LR	
731 - 115L	WHO 15LR	
731 - 118L	WHO 18LR	
731 - 122L	WHO 22LR	
731 - 128L	WHO 28LR	
731 - 135L	WHO 35LR	
731 - 142L	WHO 42LR	
731 - 106S	WHO 06SR	
731 - 108S	WHO 08SR	
731 - 110S	WHO 10SR	
731 - 112S	WHO 12SR	
731 - 114S	WHO 14SR	
731 - 116S	WHO 16SR	
731 - 120S	WHO 20SR	
731 - 125S	WHO 25SR	
731 - 130S	WHO 30SR	
731 - 138S	WHO 38SR	



## Steel Pipe Fittings DIN2353

	Part No.	Description	Price (ZAR)
<p><b>Elbow union fittings</b></p>	302 - 06L	WSV 06L	
	302 - 08L	WSV 08L	
	302 - 10L	WSV 10L	
	302 - 12L	WSV 12L	
	302 - 15L	WSV 15L	
	302 - 18L	WSV 18L	
	302 - 22L	WSV 22L	
	302 - 28L	WSV 28L	
	302 - 35L	WSV 35L	
	302 - 42L	WSV 42L	
	302 - 06S	WSV 06S	
	302 - 08L	WSV 08L	
	302 - 10S	WSV 10S	
	302 - 12S	WSV 12S	
	302 - 14S	WSV 14S	
	302 - 16S	WSV 16S	
	302 - 20S	WSV 20S	
	302 - 25S	WSV 25S	
	302 - 30S	WSV 30S	
	302 - 38S	WSV 38S	