

# Adaptors



# Adaptors

	Part No.	Description	Price (ZAR)
		<b>JIC - NPT STRAIGHT</b>	
	I202 - 02 - 02		
	I202 - 02 - 04		
	I202 - 02 - 05		
	I202 - 02 - 06		
	I202 - 04 - 04		
	I202 - 04 - 05		
	I202 - 04 - 06		
	I202 - 04 - 08		
	I202 - 06 - 04		
	I202 - 06 - 05		
	I202 - 06 - 06		
	I202 - 06 - 08		
	I202 - 06 - 06		
	I202 - 08 - 10		
	I202 - 08 - 06		
I202 - 08 - 08			
I202 - 08 - 10			
I202 - 08 - 12			
I202 - 12 - 06			
I202 - 12 - 10			
I202 - 12 - 12			
I202 - 12 - 16			
		<b>JIC STRAIGHT</b>	
	I202 - 16 - 10		
	I202 - 16 - 12		
	I202 - 16 - 16		
	I202 - 16 - 20		
	I202 - 20 - 16		
	I202 - 20 - 20		
	I202 - 20 - 24		
	I202 - 24 - 20		
	I202 - 24 - 24		
	I202 - 20 - 32		
	I202 - 32 - 32		
I202 - 32 - 24			
I202 - 24 - 34			
		<b>JIC - JIC STRAIGHT</b>	
I204 - 04 - 04			
I204 - 05 - 05			
I204 - 06 - 04			
I204 - 06 - 06			
I204 - 08 - 06			
I204 - 08 - 08			
I204 - 10 - 08			
I204 - 10 - 10			
I204 - 12 - 10			

	Part No.	Description	Price (ZAR)
	1204 - 12 - 12		
	1204 - 16 - 16		
	1204 - 20 - 20		
	1204 - 24 - 24		
	1204 - 32 - 32		
		<b>NPT - JIC 45</b>	
	1206 - 02 - 04		
	1206 - 02 - 05		
	1206 - 02 - 06		
	1206 - 04 - 04		
	1206 - 04 - 05		
	1206 - 04 - 06		
	1206 - 04 - 08		
	1206 - 06 - 04		
	1206 - 06 - 06		
	1206 - 06 - 08		
	1206 - 06 - 10		
	1206 - 08 - 06		
	1206 - 08 - 08		
	1206 - 08 - 10		
	1206 - 08 - 12		
	1206 - 12 - 08		
	1206 - 12 - 10		
	1206 - 12 - 12		
	1206 - 12 - 14		
	1206 - 12 - 16		
	1206 - 16 - 12		
1206 - 16 - 16			
1206 - 20 - 20			
1206 - 24 - 24			
1206 - 32 - 32			
		<b>NPT - JIC 90</b>	
	1208 - 02 - 02		
	1208 - 02 - 04		
	1208 - 02 - 05		
	1208 - 02 - 06		
	1208 - 04 - 04		
	1208 - 04 - 05		
	1208 - 04 - 06		
	1208 - 04 - 08		
	1208 - 06 - 04		
	1208 - 06 - 05		
	1208 - 06 - 06		
	1208 - 06 - 08		
	1208 - 06 - 10		
1208 - 08 - 04			
1208 - 08 - 06			

# Adaptors

	Part No.	Description	Price (ZAR)
	I208 - 08 - 08		
	I208 - 08 - 10		
	I208 - 12 - 08		
	I208 - 12 - 10		
	I208 - 12 - 12		
	I208 - 12 - 14		
	I208 - 12 - 16		
	I208 - 16 - 12		
	I208 - 16 - 16		
	I208 - 16 - 20		
	I208 - 20 - 16		
	I208 - 20 - 20		
	I208 - 20 - 24		
	I208 - 24 - 20		
	I208 - 24 - 24		
	I208 - 32 - 32		
	<b>NPT MALE / FEMALE</b>		
	I210 - 02 - 02		
	I210 - 02 - 04		
	I210 - 04 - 02		
	I210 - 04 - 04		
	I210 - 04 - 06		
	I210 - 06 - 04		
	I210 - 06 - 06		
	I210 - 06 - 08		
	I210 - 08 - 04		
	I210 - 08 - 05		
	I210 - 08 - 08		
	I210 - 08 - 12		
	I210 - 12 - 06		
	I210 - 12 - 12		
	I210 - 12 - 16		
	I210 - 16 - 12		
I210 - 16 - 16			
I210 - 16 - 20			
I210 - 20 - 16			
I210 - 20 - 20			
I210 - 20 - 24			
I210 - 24 - 20			
I210 - 24 - 24			
I210 - 32 - 32			

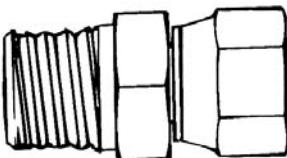
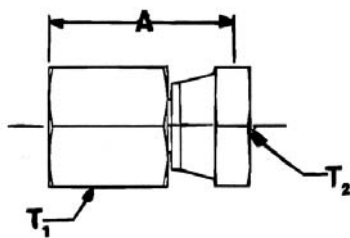
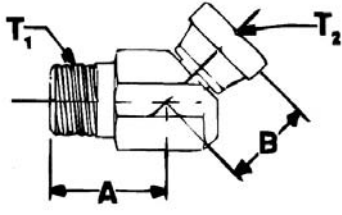
	Part No.	Description	Price (ZAR)
		<b>NPT MALE / FEMALE JIC</b>	
	1211 - 02 - 04		
	1211 - 04 - 04		
	1211 - 04 - 06		
	1211 - 06 - 06		
	1211 - 06 - 08		
	1211 - 08 - 08		
	1211 - 08 - 10		
	1211 - 12 - 12		
1211 - 16 - 16			
		<b>NPT FEMALE / NPT FEMALE</b>	
	1212 - 02 - 02		
	1212 - 02 - 04		
	1212 - 04 - 04		
	1212 - 04 - 06		
	1212 - 06 - 04		
	1212 - 06 - 06		
	1212 - 06 - 08		
	1212 - 08 - 06		
	1212 - 08 - 08		
	1212 - 08 - 12		
	1212 - 12 - 08		
	1212 - 12 - 12		
	1212 - 16 - 16		
1212 - 20 - 20			
1212 - 24 - 24			
1212 - 32 - 32			
		<b>NPT / NPT FEMALE 45</b>	
	1214 - 02 - 02		
	1214 - 04 - 04		
	1214 - 06 - 04		
	1214 - 06 - 06		
	1214 - 08 - 04		
	1214 - 08 - 06		
	1214 - 08 - 08		
	1214 - 08 - 12		
	1214 - 12 - 08		
	1214 - 12 - 12		
	1214 - 12 - 16		
	1214 - 16 - 12		
	1214 - 16 - 16		
	1214 - 16 - 20		
	1214 - 20 - 16		
	1214 - 20 - 20		
1214 - 24 - 24			
1214 - 32 - 32			

# Adaptors

	Part No.	Description	Price (ZAR)
		<b>JIC FEMALE / MALE</b>	
	1215 - 04 - 04		
	1215 - 04 - 06		
	1215 - 06 - 06		
	1215 - 06 - 08		
	1215 - 08 - 08		
	1215 - 08 - 10		
	1215 - 12 - 12		
	1215 - 12 - 14		
	1215 - 16 - 16		
			<b>NPT FEMALE / FEMALE 90</b>
	1216 - 02 - 02		
	1216 - 04 - 04		
	1216 - 06 - 04		
	1216 - 06 - 06		
	1216 - 06 - 08		
	1216 - 08 - 06		
	1216 - 08 - 08		
	1216 - 12 - 08		
	1216 - 12 - 12		
	1216 - 16 - 16		
	1216 - 20 - 20		
	1216 - 24 - 24		
	1216 - 32 - 32		
		<b>NPT FEMALE / MALE 90</b>	
	1218 - 02 - 02		
	1218 - 02 - 04		
	1218 - 04 - 02		
	1218 - 04 - 04		
	1218 - 04 - 06		
	1218 - 06 - 04		
	1218 - 06 - 06		
	1218 - 06 - 08		
	1218 - 08 - 04		
	1218 - 08 - 06		
	1218 - 08 - 08		
	1218 - 08 - 12		
	1218 - 12 - 08		
	1218 - 12 - 12		
	1218 - 12 - 16		
	1218 - 16 - 12		
	1218 - 16 - 16		
	1218 - 16 - 20		
	1218 - 20 - 16		
	1218 - 20 - 20		
1218 - 24 - 20			
1218 - 24 - 24			
1218 - 32 - 32			

	Part No.	Description	Price (ZAR)
<b>JIC MALE T-PIECE</b>			
	1220 - 04 - 04 - 04		
	1220 - 05 - 05 - 05		
	1220 - 06 - 06 - 06		
	1220 - 08 - 08 - 08		
	1220 - 10 - 10 - 10		
	1220 - 12 - 12 - 12		
	1220 - 16 - 16 - 16		
	1220 - 20 - 20 - 20		
	1220 - 24 - 24 - 24		
	<b>JIC T-PIECE NPT MALE ON BRANCH</b>		
	1221 - 02 - 04 - 04		
	1221 - 02 - 05 - 05		
	1221 - 04 - 04 - 04		
	1221 - 04 - 05 - 05		
	1221 - 04 - 06 - 06		
	1221 - 06 - 06 - 06		
	1221 - 06 - 08 - 08		
	1221 - 08 - 08 - 08		
	1221 - 08 - 10 - 10		
	1221 - 12 - 12 - 12		
	1221 - 14 - 14 - 14		
	1221 - 16 - 16 - 16		
	1221 - 20 - 20 - 20		
	1221 - 24 - 24 - 24		
	1221 - 32 - 32 - 32		
<b>JIC T-PIECE NPT MALE ON RUN</b>			
	1224 - 02 - 04 - 04		
	1224 - 02 - 05 - 05		
	1224 - 04 - 04 - 04		
	1224 - 04 - 06 - 06		
	1224 - 06 - 06 - 06		
	1224 - 06 - 08 - 08		
	1224 - 08 - 08 - 08		
	1224 - 08 - 10 - 10		
	1224 - 12 - 12 - 12		
	1224 - 12 - 14 - 14		
	1224 - 16 - 16 - 16		
	1224 - 20 - 20 - 20		
	1224 - 24 - 24 - 24		

# Adaptors

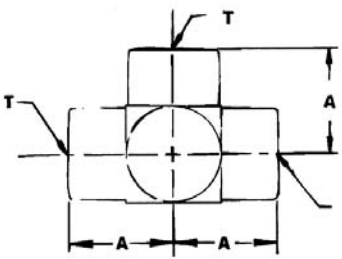
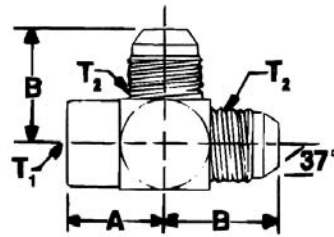
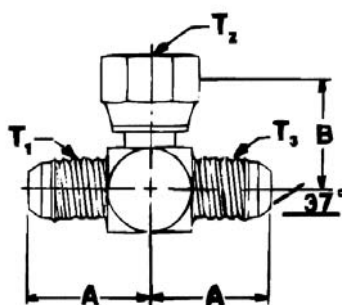
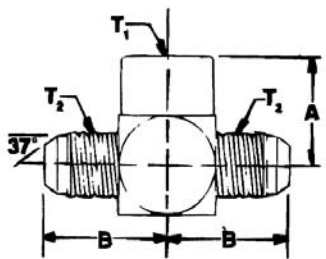
	Part No.	Description	Price (ZAR)
		<b>FEMALE NPT T-PIECE</b>	
	1225 - 02 - 02 - 02		
	1225 - 04 - 04 - 04		
	1225 - 06 - 06 - 06		
	1225 - 08 - 08 - 08		
	1225 - 12 - 12 - 12		
	1225 - 16 - 16 - 16		
	1225 - 20 - 20 - 20		
	1225 - 24 - 24 - 24		
		<b>JIC T-PIECE NPT FEMALE ON RUN</b>	
	1226 - 02 - 04 - 04		
	1226 - 04 - 06 - 06		
	1226 - 06 - 08 - 08		
	1226 - 08 - 10 - 10		
	1226 - 12 - 12 - 12		
	1226 - 12 - 14 - 14		
	1226 - 16 - 16 - 16		
	1226 - 20 - 20 - 20		
1226 - 24 - 24 - 24			
		<b>JIC T-PIECE FEMALE ON BRANCH</b>	
	1227 - 04 - 04 - 04		
	1227 - 05 - 05 - 05		
	1227 - 06 - 06 - 06		
	1227 - 08 - 08 - 08		
	1227 - 10 - 10 - 10		
	1227 - 12 - 12 - 12		
	1227 - 14 - 14 - 14		
	1227 - 16 - 16 - 16		
1227 - 20 - 20 - 20			
1227 - 24 - 24 - 24			
		<b>JIC T/NPT FEMALE ON BRANCH</b>	
	1228 - 02 - 04 - 04		
	1228 - 02 - 05 - 05		
	1228 - 04 - 04 - 04		
	1228 - 04 - 06 - 06		
	1228 - 06 - 06 - 06		
	1228 - 06 - 08 - 08		
	1228 - 08 - 08 - 08		
	1228 - 08 - 10 - 10		
1228 - 12 - 12 - 12			
1228 - 20 - 20 - 20			
1228 - 24 - 24 - 24			



	Part No.	Description	Price (ZAR)
	1229 - 04 - 04 - 04	<b>JIC CROSS</b>	
	1229 - 05 - 05 - 05		
	1229 - 06 - 06 - 06		
	1229 - 08 - 08 - 08		
	1229 - 10 - 10 - 10		
	1229 - 12 - 12 - 12		
	1229 - 14 - 14 - 14		
	1229 - 16 - 16 - 16		
	1229 - 20 - 20 - 20		
	1229 - 24 - 24 - 24		
			1230 - 02 - 04
1230 - 02 - 05			
1230 - 04 - 04			
1230 - 04 - 05			
1230 - 04 - 06			
1230 - 06 - 06			
1230 - 06 - 08			
1230 - 06 - 10			
1230 - 08 - 08			
1230 - 08 - 10			
1230 - 12 - 12			
1230 - 12 - 14			
1230 - 16 - 16			
1230 - 20 - 20			
1230 - 24 - 24			
1230 - 32 - 32			
	1231 - 04 - 04	<b>JIC SAE STRAIGHT</b>	
	1231 - 04 - 05		
	1231 - 04 - 06		
	1231 - 04 - 08		
	1231 - 04 - 10		
	1231 - 05 - 04		
	1231 - 05 - 05		
	1231 - 05 - 06		
	1231 - 06 - 04		
	1231 - 06 - 05		
	1231 - 06 - 06		
	1231 - 06 - 08		
	1231 - 06 - 10		
	1231 - 08 - 06		
	1231 - 08 - 08		
	1231 - 08 - 10		
	1231 - 08 - 12		
	1231 - 10 - 08		
	1231 - 10 - 10		

# Adaptors

	Part No.	Description	Price (ZAR)
	1231 - 10 - 12		
	1231 - 10 - 16		
	1231 - 12 - 08		
	1231 - 12 - 10		
	1231 - 12 - 12		
	1231 - 12 - 14		
	1231 - 12 - 16		
	1231 - 12 - 20		
	1231 - 14 - 14		
	1231 - 16 - 08		
	1231 - 16 - 10		
	1231 - 16 - 12		
	1231 - 16 - 14		
	1231 - 16 - 16		
	1231 - 16 - 20		
	1231 - 20 - 16		
	1231 - 20 - 20		
	1231 - 20 - 24		
1231 - 24 - 20			
1231 - 24 - 24			
1231 - 24 - 32			
1231 - 32 - 24			
1231 - 32 - 32			
		<b>JIC / SAE STRAIGHT LONG</b>	
	1231 - LO - 06 - 06		
	1231 - LO - 08 - 08		
	1231 - LO - 10 - 10		
	1231 - LO - 12 - 12		
	1231 - LO - 16 - 16		
		<b>JIC MALE JIC MALE 90 ELB</b>	
	1234 - 04 - 04		
	1234 - 05 - 05		
	1234 - 06 - 04		
	1234 - 06 - 06		
	1234 - 08 - 08		
	1234 - 10 - 10		
	1234 - 12 - 12		
	1234 - 14 - 14		
	1234 - 16 - 16		
	1234 - 20 - 20		
	1234 - 24 - 24		
	1234 - 32 - 32		

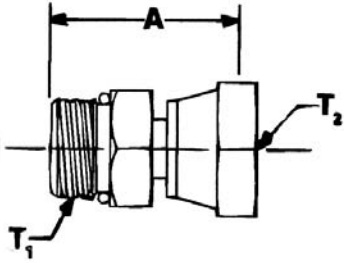
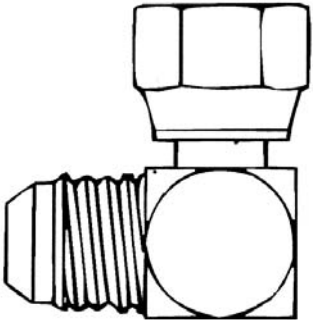
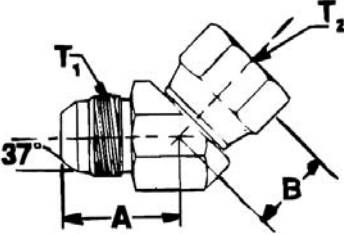
	Part No.	Description	Price (ZAR)
		<b>M / SAE OR / B-NPT F/M SWIVEL</b>	
	I235 - 04 - 04		
	I235 - 05 - 04		
	I235 - 06 - 04		
	I235 - 06 - 06		
	I235 - 08 - 04		
	I235 - 08 - 06		
	I235 - 08 - 08		
	I235 - 08 - 12		
	I235 - 10 - 06		
	I235 - 10 - 08		
	I235 - 10 - 12		
	I235 - 12 - 08		
	I235 - 12 - 12		
	I235 - 12 - 16		
	I235 - 14 - 12		
	I235 - 16 - 12		
	I235 - 16 - 16		
	I235 - 20 - 12		
I235 - 20 - 16			
I235 - 20 - 20			
I235 - 24 - 24			
I235 - 32 - 32			
		<b>MALE JIC-FEMALE JIC 90 ELB</b>	
	I236 - 04 - 04		
	I236 - 05 - 05		
	I236 - 06 - 06		
	I236 - 08 - 08		
	I236 - 10 - 10		
	I236 - 12 - 12		
	I236 - 14 - 14		
	I236 - 16 - 16		
	I236 - 20 - 20		
	I236 - 24 - 24		
		<b>MALE JIC-FEMALE JIC 45 ELB</b>	
	I237 - 04 - 04		
	I237 - 06 - 06		
	I237 - 08 - 08		
	I237 - 10 - 10		
	I237 - 12 - 12		
	I237 - 16 - 16		
	I237 - 20 - 20		
	I237 - 24 - 24		

# Adaptors

	Part No.	Description	Price (ZAR)
		<b>JIC SAE 90 MALE</b>	
	1238 - 04 - 04		
	1238 - 04 - 05		
	1238 - 04 - 06		
	1238 - 05 - 04		
	1238 - 05 - 05		
	1238 - 05 - 06		
	1238 - 06 - 04		
	1238 - 06 - 05		
	1238 - 06 - 06		
	1238 - 06 - 08		
	1238 - 08 - 06		
	1238 - 08 - 08		
	1238 - 08 - 10		
	1238 - 08 - 12		
	1238 - 10 - 06		
	1238 - 10 - 08		
	1238 - 10 - 10		
	1238 - 10 - 12		
	1238 - 12 - 08		
	1238 - 12 - 10		
	1238 - 12 - 12		
	1238 - 12 - 16		
	1238 - 16 - 12		
	1238 - 16 - 16		
1238 - 16 - 20			
1238 - 20 - 16			
1238 - 20 - 20			
1238 - 20 - 24			
1238 - 24 - 24			
		<b>JIC SAE 45 MALE</b>	
	1240 - 04 - 04		
	1240 - 05 - 05		
	1240 - 06 - 06		
	1240 - 06 - 08		
	1240 - 08 - 06		
	1240 - 08 - 08		
	1240 - 08 - 10		
	1240 - 10 - 08		
	1240 - 10 - 10		
	1240 - 10 - 12		
	1240 - 12 - 12		
	1240 - 12 - 16		
	1240 - 16 - 12		
	1240 - 20 - 20		
	1240 - 24 - 24		
	1240 - 32 - 32		

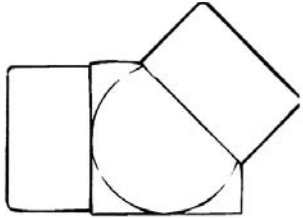
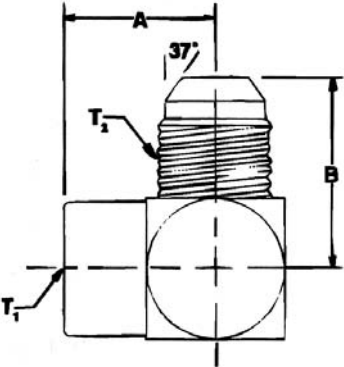
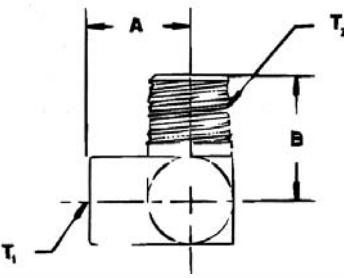
	Part No.	Description	Price (ZAR)
		<b>NPT FEMALE 45</b>	
	I241 - 04 - 04		
	I241 - 06 - 06		
	I241 - 08 - 08		
	I241 - 12 - 12		
	I241 - 16 - 16		
		<b>MALE 90 FEMALE NPT</b>	
	I242 - 02 - 04		
	I242 - 02 - 05		
	I242 - 02 - 06		
	I242 - 04 - 04		
	I242 - 04 - 05		
	I242 - 04 - 06		
	I242 - 06 - 06		
	I242 - 06 - 08		
	I242 - 08 - 08		
	I242 - 08 - 10		
	I242 - 12 - 12		
	I242 - 16 - 16		
	I242 - 20 - 20		
	I242 - 24 - 24		
	I242 - 32 - 32		
		<b>MALE FEMALE 90 NPT</b>	
	I243 - 02 - 02		
	I243 - 02 - 04		
	I243 - 04 - 02		
	I243 - 04 - 04		
	I243 - 04 - 06		
	I243 - 06 - 04		
	I243 - 06 - 06		
	I243 - 06 - 08		
	I243 - 08 - 06		
	I243 - 08 - 08		
	I243 - 08 - 12		
	I243 - 12 - 08		
	I243 - 12 - 12		
	I243 - 16 - 16		
	I243 - 20 - 20		

# Adaptors

	Part No.	Description	Price (ZAR)
		<b>FEMALE NPT 90</b>	
	1245 - 02 - 02		
	1245 - 04 - 02		
	1245 - 04 - 04		
	1245 - 06 - 04		
	1245 - 06 - 06		
	1245 - 08 - 06		
	1245 - 08 - 08		
	1245 - 08 - 12		
	1245 - 12 - 12		
	1245 - 16 - 16		
	1245 - 20 - 20		
	1245 - 24 - 24		
			<b>JICT PIECE FEMALE ON RUN</b>
	1248 - 04 - 04 - 04		
	1248 - 05 - 05 - 05		
	1248 - 06 - 06 - 06		
	1248 - 08 - 08 - 08		
	1248 - 10 - 10 - 10		
	1248 - 12 - 12 - 12		
	1248 - 16 - 16 - 16		
	1248 - 20 - 20 - 20		
1248 - 24 - 24 - 24			
		<b>NPT REDUCING BRUSH</b>	
	1250 - 04 - 02		
	1250 - 06 - 02		
	1250 - 06 - 04		
	1250 - 08 - 04		
	1250 - 08 - 06		
	1250 - 12 - 04		
	1250 - 12 - 06		
	1250 - 12 - 08		
	1250 - 16 - 04		
	1250 - 16 - 06		
	1250 - 16 - 08		
	1250 - 16 - 12		
	1250 - 20 - 08		
	1250 - 20 - 12		
	1250 - 20 - 16		
	1250 - 24 - 12		
1250 - 24 - 16			
1250 - 24 - 20			
1250 - 32 - 16			
1250 - 32 - 20			
1250 - 32 - 24			

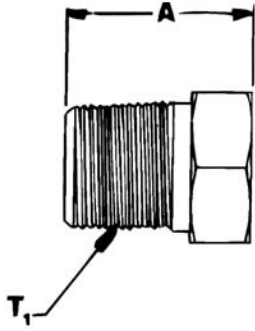
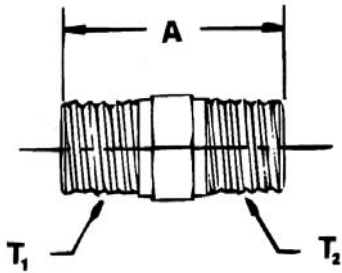
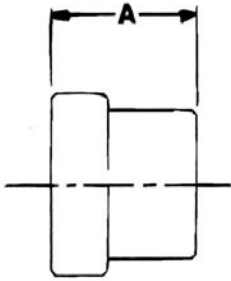
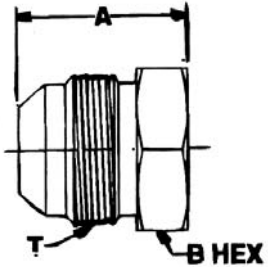
	Part No.	Description	Price (ZAR)
		<b>NPT MALE PLUG</b>	
	1251 - 02		
	1251 - 04		
	1251 - 06		
	1251 - 08		
	1251 - 12		
	1251 - 16		
	1251 - 20		
	1251 - 24		
	1251 - 32		
		<b>NPT MALE NIPPLE</b>	
	1252 - 02 - 02		
	1252 - 04 - 02		
	1252 - 04 - 04		
	1252 - 06 - 02		
	1252 - 06 - 04		
	1252 - 06 - 06		
	1252 - 08 - 04		
	1252 - 08 - 06		
	1252 - 08 - 08		
	1252 - 12 - 08		
	1252 - 12 - 12		
	1252 - 16 - 12		
	1252 - 16 - 16		
	1252 - 20 - 16		
	1252 - 20 - 20		
1252 - 24 - 24			
1252 - 32 - 32			
		<b>JIC SLEEVE</b>	
	1253 - 04		
	1253 - 05		
	1253 - 06		
	1253 - 08		
	1253 - 10		
	1253 - 12		
	1253 - 16		
	1253 - 20		
1253 - 24			
		<b>JIC MALE PLUG</b>	
	1254 - 04		
	1254 - 05		
	1254 - 06		
	1254 - 08		
	1254 - 10		
	1254 - 12		
	1254 - 16		
	1254 - 20		
	1254 - 24		
1254 - 32			

# Adaptors

	Part No.	Description	Price (ZAR)
		<b>SAE MALE PLUG</b>	
	1255 - 03		
	1255 - 04		
	1255 - 05		
	1255 - 06		
	1255 - 08		
	1255 - 10		
	1255 - 12		
	1255 - 14		
	1255 - 16		
	1255 - 20		
	1255 - 24		
1255 - 32			
		<b>NPT MALE-NPT F/M SWIVEL T</b>	
	1258 - 02 - 02 - 02		
	1258 - 04 - 04 - 04		
	1258 - 06 - 04 - 04		
	1258 - 06 - 06 - 06		
	1258 - 08 - 04 - 04		
	1258 - 08 - 06 - 06		
	1258 - 08 - 08 - 08		
	1258 - 12 - 08 - 08		
	1258 - 12 - 12 - 12		
	1258 - 12 - 16 - 16		
	1258 - 16 - 12 - 12		
1258 - 16 - 16 - 16			
1258 - 20 - 20 - 20			
1258 - 24 - 24 - 24			
		<b>NPT RING F/M-NPT F/M SWIVEL T</b>	
	1259 - 02 - 02 - 02		
	1259 - 04 - 04 - 04		
	1259 - 06 - 04 - 04		
	1259 - 06 - 06 - 06		
	1259 - 06 - 08 - 08		
	1259 - 08 - 08 - 08		
		<b>JIC MALE BULKHEAD</b>	
	1260 - 04 - 04		
	1260 - 05 - 05		
	1260 - 06 - 06		
	1260 - 08 - 08		
	1260 - 10 - 10		
	1260 - 12 - 12		
1260 - 16 - 16			



	Part No.	Description	Price (ZAR)
	<b>JIC 90 BULKHEAD</b>		
	1262 - 04 - 04 - 04		
	1262 - 05 - 05 - 05		
	1262 - 06 - 06 - 06		
	1262 - 08 - 08 - 08		
	1262 - 10 - 10 - 10		
	1262 - 12 - 12 - 12		
	1262 - 16 - 16 - 16		
	<b>SAE O RING M/JIC - M/JIC</b>		
	1265 - 04 - 04 - 04		
	1265 - 05 - 05 - 05		
	1265 - 06 - 06 - 06		
	1265 - 08 - 08 - 08		
	1265 - 10 - 10 - 10		
	1265 - 12 - 12 - 12		
	1265 - 14 - 14 - 14		
	<b>SAE JIC JIC T PIECE</b>		
	1266 - 04 - 04 - 04		
	1266 - 05 - 05 - 05		
	1266 - 06 - 06 - 06		
	1266 - 08 - 08 - 08		
	1266 - 10 - 10 - 10		
	1266 - 12 - 12 - 12		
	1266 - 14 - 14 - 14		
	<b>FEMALE PIPE MALE O R/BOSS</b>		
	1268 - 02 - 04		
	1268 - 02 - 05		
	1268 - 02 - 06		
	1268 - 04 - 04		
	1268 - 04 - 06		
	1268 - 06 - 06		
	1268 - 06 - 08		
	1268 - 06 - 10		
	1268 - 08 - 06		
	1268 - 08 - 08		
	1268 - 08 - 10		
1268 - 08 - 12			
1268 - 12 - 12			
1268 - 12 - 16			
1268 - 16 - 16			
1268 - 16 - 20			
1268 - 20 - 20			

# Adaptors

	Part No.	Description	Price (ZAR)
		<b>SAE MALE NPT FEMALE SWIVEL 90</b>	
	1271 - 04 - 04		
	1271 - 06 - 04		
	1271 - 06 - 06		
	1271 - 06 - 08		
	1271 - 08 - 06		
	1271 - 08 - 08		
	1271 - 08 - 12		
	1271 - 10 - 06		
	1271 - 10 - 08		
	1271 - 10 - 12		
	1271 - 12 - 08		
	1271 - 12 - 12		
	1271 - 16 - 12		
	1271 - 16 - 16		
	1271 - 20 - 12		
	1271 - 20 - 20		
		<b>NPT SOCKET</b>	
	1273 - 02 - 02		
	1273 - 04 - 02		
	1273 - 04 - 04		
	1273 - 06 - 04		
	1273 - 06 - 06		
	1273 - 08 - 04		
	1273 - 08 - 06		
	1273 - 08 - 08		
	1273 - 12 - 08		
	1273 - 12 - 12		
	1273 - 16 - 12		
	1273 - 16 - 16		
1273 - 20 - 20			
1273 - 24 - 24			
		<b>NPT MALE - FEMALE</b>	
	1274 - 02 - 04		
	1274 - 04 - 06		
	1274 - 06 - 08		
	1274 - 08 - 12		
	1274 - 12 - 16		
	1274 - 16 - 20		

	Part No.	Description	Price (ZAR)
		<b>NPT MALE 90 ELB</b>	
	1275 - 02 - 02		
	1275 - 04 - 04		
	1275 - 06 - 04		
	1275 - 06 - 06		
	1275 - 08 - 06		
	1275 - 08 - 08		
	1275 - 12 - 08		
	1275 - 12 - 12		
	1275 - 16 - 12		
	1275 - 16 - 16		
	1275 - 20 - 20		
		<b>NPT MALE - FEMALE T</b>	
	1276 - 02 - 02 - 02		
	1276 - 04 - 04 - 04		
	1276 - 06 - 06 - 06		
	1276 - 08 - 08 - 08		
	1276 - 12 - 12 - 12		
1276 - 16 - 16 - 16			
		<b>NPT MALE - FEMALE T</b>	
	1278 - 02 - 02 - 02		
	1278 - 04 - 04 - 04		
	1278 - 06 - 06 - 06		
	1278 - 08 - 08 - 08		
	1278 - 12 - 12 - 12		
	1278 - 16 - 16 - 16		
1278 - 20 - 20 - 20			
		<b>NPT FEMALE CROSS</b>	
	1279 - 02 - 02 - 02 - 02		
	1279 - 04 - 04 - 04 - 04		
	1279 - 06 - 06 - 06 - 06		
	1279 - 08 - 08 - 08 - 08		
1279 - 12 - 12 - 12 - 12			
		<b>JIC BULKHEAD T</b>	
	1283 - 04 - 04 - 04		
	1283 - 05 - 05 - 05		
	1283 - 06 - 06 - 06		
	1283 - 08 - 08 - 08		
	1283 - 10 - 10 - 10		
	1283 - 12 - 12 - 12		
1283 - 16 - 16 - 16			

# Adaptors

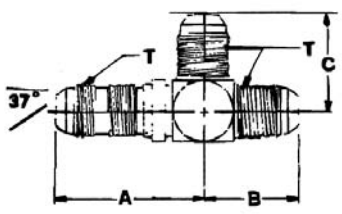
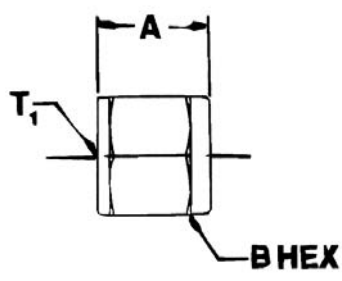
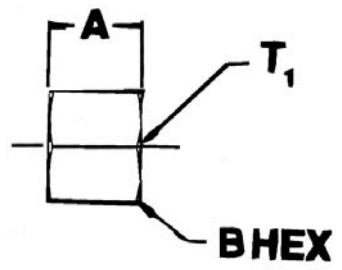
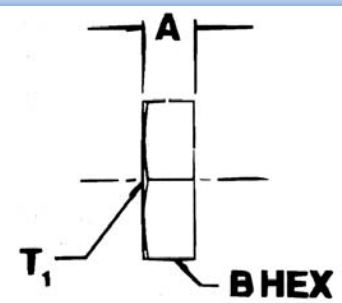
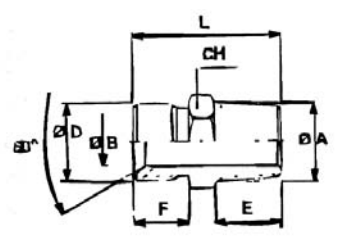
	Part No.	Description	Price (ZAR)
	1284 - 04 - 04 - 04	<b>JIC BULKHEAD RUN T</b>	
	1284 - 05 - 05 - 05		
	1284 - 06 - 06 - 06		
	1284 - 08 - 08 - 08		
	1284 - 10 - 10 - 10		
	1284 - 12 - 12 - 12		
	1284 - 16 - 16 - 16		
	1311 - 04	<b>JIC NUT</b>	
	1311 - 05		
	1311 - 06		
	1311 - 08		
	1311 - 10		
	1311 - 12		
	1311 - 14		
	1311 - 16		
1311 - 20			
1311 - 24			
	1329 - 04	<b>JIC CAP NUT</b>	
	1329 - 05		
	1329 - 06		
	1329 - 08		
	1329 - 10		
	1329 - 12		
	1329 - 14		
	1329 - 16		
1329 - 20			
	1332 - 04	<b>BULKHEAD LOCK NUT</b>	
	1332 - 05		
	1332 - 06		
	1332 - 08		
	1332 - 10		
	1332 - 12		
	1332 - 14		
	1332 - 16		
1332 - 20			
	F III R 1/8	<b>BSP BSPT</b>	
	F III R 1/4		
	F III R 3/8		
	F III R 1/2		
	F III R 3/4		
	F III R 1"		
	F III R 1 1/4		
	F III R 1 1/2		
	F III R 2"		

	Part No.	Description	Price (ZAR)
	<b>BSP BSP</b>		
	F 113 R 1/8		
	F 113 R 1/4		
	F 113 R 3/8		
	F 113 R 1/2		
	F 113 R 5/8		
	F 113 R 3/4		
	F 113 R 1"		
	F 113 R 1 1/4		
	F 113 R 1 1/2		
F 113 R 2"			
	<b>BSP BSP JUMP</b>		
	F 114 R 1/8 x 1/4		
	F 114 R 3/8 x 1/4		
	F 114 R 1/2 x 1/4		
	F 114 R 1/2 x 3/8		
	F 114 R 5/8 x 1/2		
	F 114 R 3/4 x 3/8		
	F 114 R 3/4 x 1/2		
	F 114 R 3/4 x 5/8		
	F 114 R 1" x 1/2		
	F 114 R 1" x 3/4		
	F 114 R 1 1/4 x 3/4		
	F 114 R 1 1/4 x 1"		
	F 114 R 1 1/2 x 1"		
	F 114 R 1 1/2 x 1 1/4		
F 114 R 2" x 1 1/2			
<b>JIC BSP</b>			
MCJB - 04 - 04			
MCJB - 04 - 06			
MCJB - 06 - 04			
MCJB - 06 - 06			
MCJB - 06 - 08			
MCJB - 08 - 06			
MCJB - 08 - 08			
MCJB - 08 - 12			
MCJB - 10 - 08			
MCJB - 10 - 12			
MCJB - 12 - 08			
MCJB - 12 - 12			
MCJB - 16 - 12			
MCJB - 16 - 16			

## Adaptors

	<b>Part No.</b>	<b>Description</b>	<b>Price (ZAR)</b>
		<b>SPRING GUARD</b>	
	SG 4		
	SG 6		
	SG 6A		
	SG 8		
	SG 8A		
	SG 10		
	SG 10A		
	SG 12		
	SG 12A		
	SG 16		
	SG 16A		
	SG 20		
	SG 20A		
	SG 24		
	SG 24A		
	SG 32		